

STT49

Thyristor-Thyristor Modules

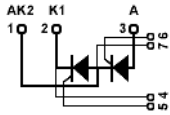
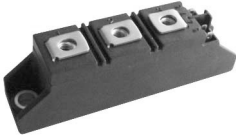

| Type | V_{RSM} | V_{RRM} |
|-----------|-----------|-----------|
| | V_{DSM} | V_{DRM} |
| | V | V |
| STT49GK08 | 900 | 800 |
| STT49GK12 | 1300 | 1200 |
| STT49GK14 | 1500 | 1400 |
| STT49GK16 | 1700 | 1600 |
| STT49GK18 | 1900 | 1800 |

Dimensions in mm (1mm=0.0394")

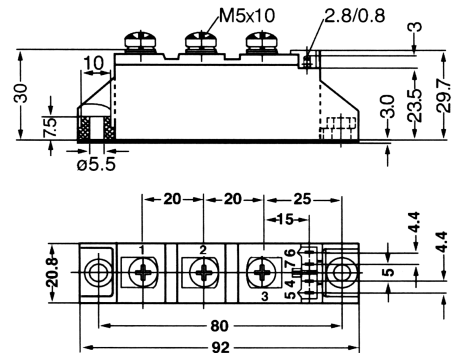

| Symbol | Test Conditions | Maximum Ratings | Unit | |
|--|--|--|---------------------------------|-------------|
| I_{TRMS}, I_{FRMS} I_{TAVM}, I_{FAVM} | $T_{VJ}=T_{VJM}$ $T_C=85^{\circ}C; 180^{\circ}$ sine | 80 49 | A | |
| I_{TSM}, I_{FSM} | $T_{VJ}=45^{\circ}C$ $V_R=0$ $t=10ms$ (50Hz), sine $t=8.3ms$ (60Hz), sine | 1150 1230 | A | |
| | $T_{VJ}=T_{VJM}$ $V_R=0$ $t=10ms$ (50Hz), sine $t=8.3ms$ (60Hz), sine | 1000 1070 | | |
| $\int i^2 dt$ | $T_{VJ}=45^{\circ}C$ $V_R=0$ $t=10ms$ (50Hz), sine $t=8.3ms$ (60Hz), sine | 6600 6280 | A ² s | |
| | $T_{VJ}=T_{VJM}$ $V_R=0$ $t=10ms$ (50Hz), sine $t=8.3ms$ (60Hz), sine | 5000 4750 | | |
| $(di/dt)_{cr}$ | $T_{VJ}=T_{VJM}$ $f=50Hz, t_p=200\mu s$ $V_D=2/3V_{DRM}$ $I_G=0.45A$ $di_G/dt=0.45A/\mu s$ | repetitive, $I_T=150A$ non repetitive, $I_T=I_{TAVM}$ | 150 500 | A/ μs |
| | $T_{VJ}=T_{VJM};$ $R_{GK}=\infty;$ method 1 (linear voltage rise) | $V_{DR}=2/3V_{DRM}$ | 1000 | |
| P_{GM} | $T_{VJ}=T_{VJM}$ $I_T=I_{TAVM}$ | $t_p=30\mu s$ $t_p=300\mu s$ | 10 5 | W |
| P_{GAV} | | | 0.5 | W |
| V_{RGM} | | | 10 | V |
| T_{VJ} T_{VJM} T_{stg} | | | -40...+125 125 -40...+125 | $^{\circ}C$ |
| V_{ISOL} | 50/60Hz, RMS $I_{ISOL} \leq 1mA$ | $t=1min$ $t=1s$ | 3000 3600 | V~ |
| M_d | Mounting torque (M5) Terminal connection torque (M5) | | 2.5-4.0/22-35 2.5-4.0/22-35 | Nm/lb.in. |
| Weight | Typical including screws | | 90 | g |

STT49

Thyristor-Thyristor Modules

| Symbol | Test Conditions | Characteristic Values | Unit |
|--------------------|---|-----------------------|-----------|
| I_{RRM}, I_{DRM} | $T_{VJ}=T_{VJM}; V_R=V_{RRM}; V_D=V_{DRM}$ | 5 | mA |
| V_T, V_F | $I_T, I_F=200A; T_{VJ}=25^{\circ}C$ | 1.75 | V |
| V_{TO} | For power-loss calculations only ($T_{VJ}=125^{\circ}C$) | 0.85 | V |
| r_T | | 5.3 | $m\Omega$ |
| V_{GT} | $V_D=6V;$ $T_{VJ}=25^{\circ}C$ $T_{VJ}=-40^{\circ}C$ | 1.5 1.6 | V |
| I_{GT} | $V_D=6V;$ $T_{VJ}=25^{\circ}C$ $T_{VJ}=-40^{\circ}C$ | 100 200 | mA |
| V_{GD} | $T_{VJ}=T_{VJM};$ $V_D=2/3V_{DRM}$ | 0.2 | V |
| I_{GD} | | 10 | mA |
| I_L | $T_{VJ}=25^{\circ}C; t_p=10\mu s; V_D=6V$ $I_G=0.45A; di_G/dt=0.45A/\mu s$ | 450 | mA |
| I_H | $T_{VJ}=25^{\circ}C; V_D=6V; R_{GK}=\infty$ | 200 | mA |
| t_{gd} | $T_{VJ}=25^{\circ}C; V_D=1/2V_{DRM}$ $I_G=0.45A; di_G/dt=0.45A/\mu s$ | 2 | μs |
| t_q | $T_{VJ}=T_{VJM}; I_T=120A; t_p=200\mu s; -di/dt=10A/\mu s$ $V_R=100V; dv/dt=20V/\mu s; V_D=2/3V_{DRM}$ | 150 | μs |
| Q_S | $T_{VJ}=T_{VJM}; I_T, I_F=50A; -di/dt=0.64A/\mu s$ | 90 | μC |
| I_{RM} | | 11 | A |
| R_{thJC} | per thyristor/diode; DC current per module | 0.53 0.265 | K/W |
| R_{thJK} | per thyristor/diode; DC current per module | 0.73 0.365 | K/W |
| d_s | Creeping distance on surface | 12.7 | mm |
| d_A | Strike distance through air | 9.6 | mm |
| a | Maximum allowable acceleration | 50 | m/s^2 |

FEATURES

- * International standard package
- * Copper base plate
- * Planar passivated chips
- * Isolation voltage 3600 V~

APPLICATIONS

- * DC motor control
- * Softstart AC motor controller
- * Light, heat and temperature control

ADVANTAGES

- * Space and weight savings
- * Simple mounting with two screws
- * Improved temperature and power cycling
- * Reduced protection circuits

STT49

Thyristor-Thyristor Modules

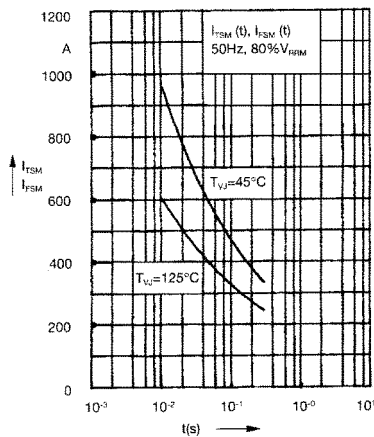

Fig. 1 Surge overload current
 I_{TSM} , I_{FSM} : Crest value, t : duration

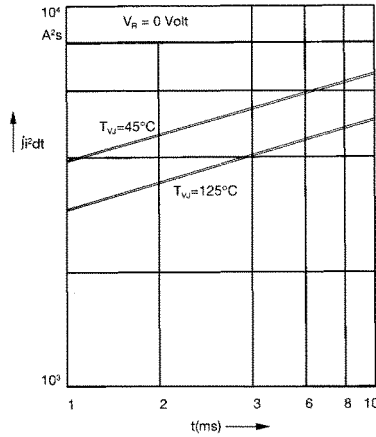

Fig. 2 $\int i^2 dt$ versus time (1-10 ms)

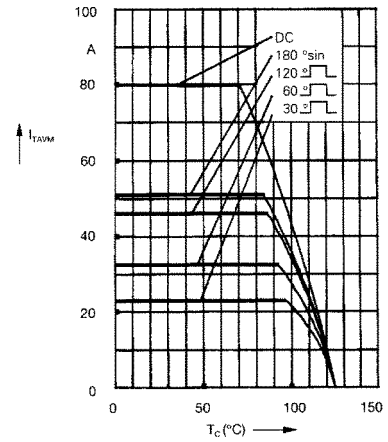

Fig. 2a Maximum forward current at case temperature

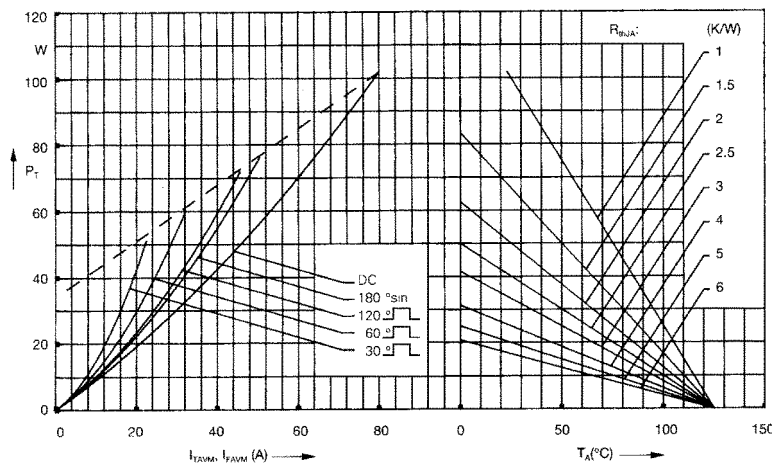

Fig. 3 Power dissipation versus on-state current and ambient temperature (per thyristor or diode)

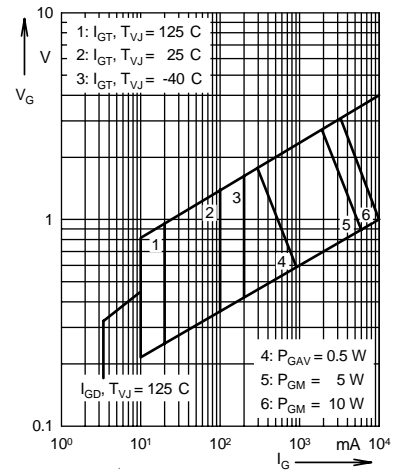

Fig. 4 Gate trigger characteristics

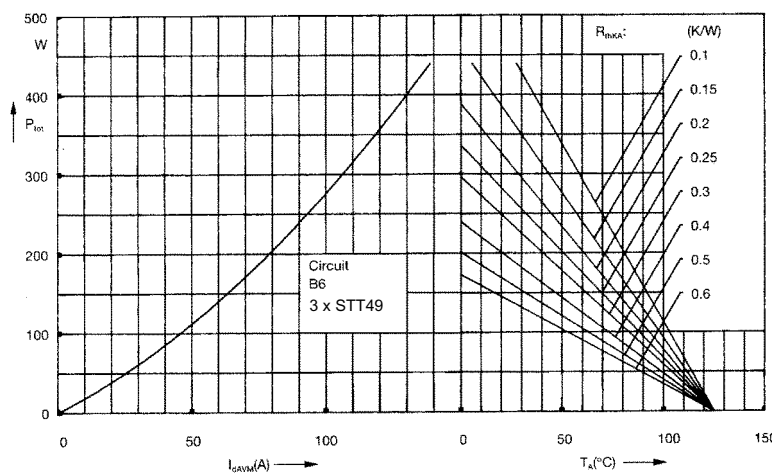

Fig. 5 Three phase rectifier bridge: Power dissipation versus direct output current and ambient temperature

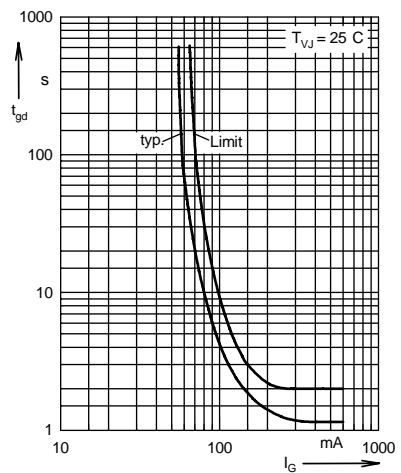

Fig. 6 Gate trigger delay time

STT49

Thyristor-Thyristor Modules

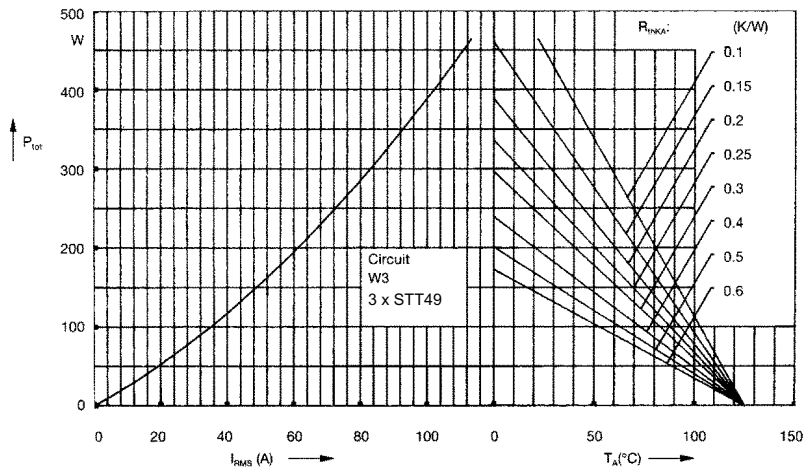

Fig. 7 Three phase AC-controller: Power dissipation versus RMS output current and ambient temperature

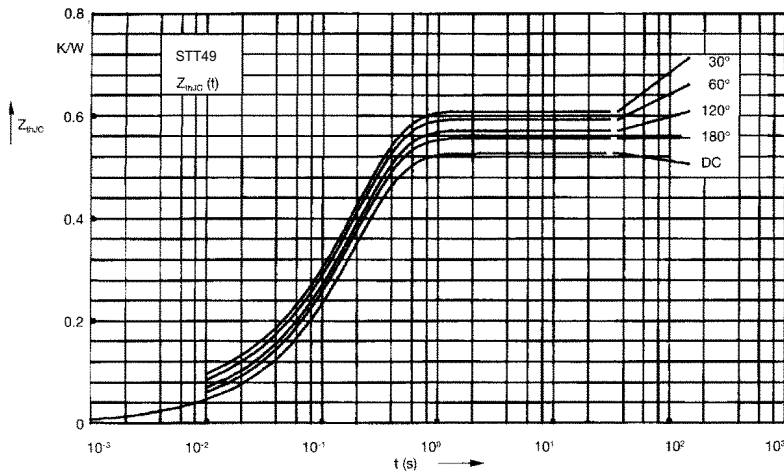

Fig. 8 Transient thermal impedance junction to case (per thyristor or diode)

R_{thJC} for various conduction angles d :

| d | R_{thJC} (K/W) |
|-------|------------------|
| DC | 0.53 |
| 180°C | 0.55 |
| 120°C | 0.58 |
| 60°C | 0.6 |
| 30°C | 0.62 |

Constants for Z_{thJC} calculation:

| i | R_{thi} (K/W) | t_i (s) |
|-----|-----------------|-----------|
| 1 | 0.015 | 0.0035 |
| 2 | 0.026 | 0.02 |
| 3 | 0.489 | 0.195 |

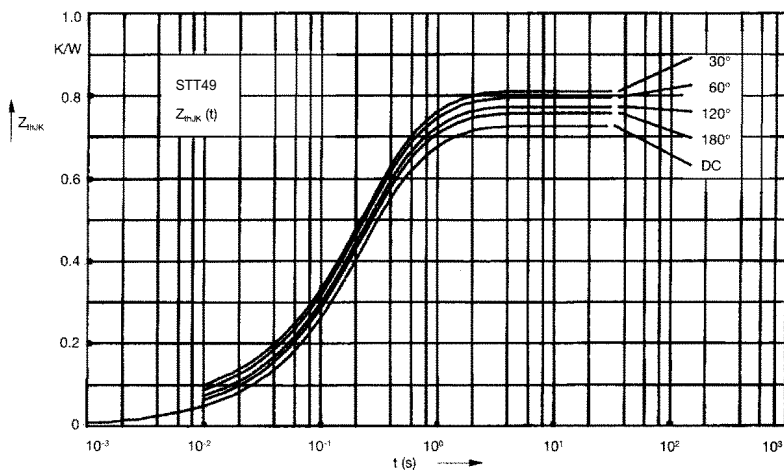

Fig. 9 Transient thermal impedance junction to heatsink (per thyristor or diode)

R_{thJK} for various conduction angles d :

| d | R_{thJK} (K/W) |
|-------|------------------|
| DC | 0.73 |
| 180°C | 0.75 |
| 120°C | 0.78 |
| 60°C | 0.8 |
| 30°C | 0.82 |

Constants for Z_{thJK} calculation:

| i | R_{thi} (K/W) | t_i (s) |
|-----|-----------------|-----------|
| 1 | 0.015 | 0.0035 |
| 2 | 0.026 | 0.02 |
| 3 | 0.489 | 0.195 |
| 4 | 0.2 | 0.68 |